

# Clutch Release Cylinder

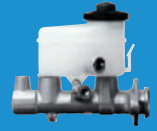

## Function

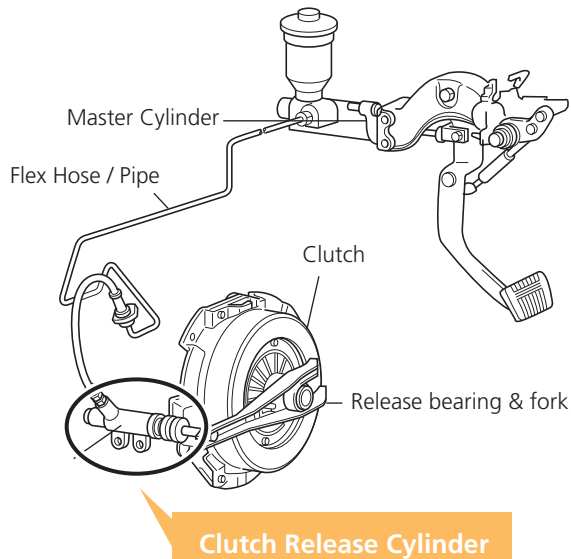

The clutch release cylinder (also known as the clutch slave cylinder) is the component that transfers hydraulic pressure, achieved through the clutch master cylinder, into a mechanical force to control the clutch fork. The force from the release cylinder engages and releases engine power to the transmission.

## Structure and Components

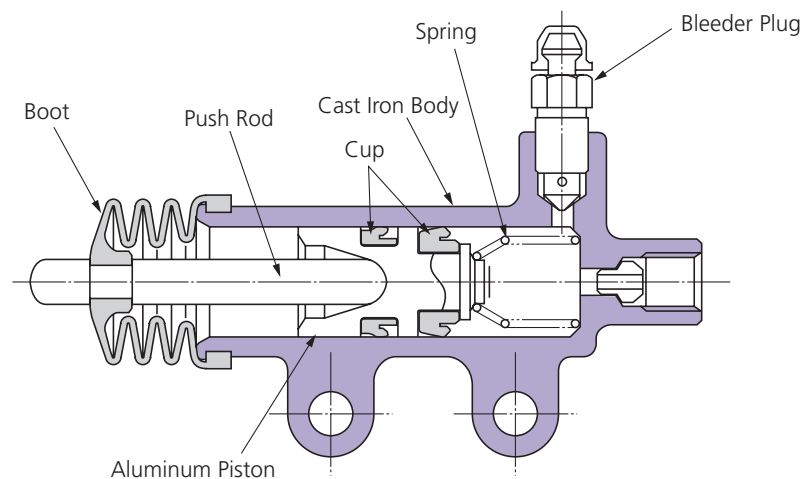

The clutch release cylinder is composed of the piston, cups, spring, and push rod, built within a precision machined body and covered with a boot. The boot provides protection from dirt, dust and debris from contaminating the push rod and piston. When the clutch pedal is pressed and the fluid pressure reaches the release cylinder, the piston moves the push rod out to apply force onto the clutch fork which releases the clutch. When the clutch pedal is released, the hydraulic pressure and the force of the return spring pulls back the push rod and sends back the fluid to the master cylinder, therefore engaging the clutch.

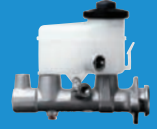

# Installation Procedure

**CAUTION!** Failure to follow recommended procedures may cause clutch failure and injury. Always consult the manufacturer's vehicle specific service manual for reference.

## 1

Do not allow dust, dirt, and debris to enter the cylinder or reservoir tank.

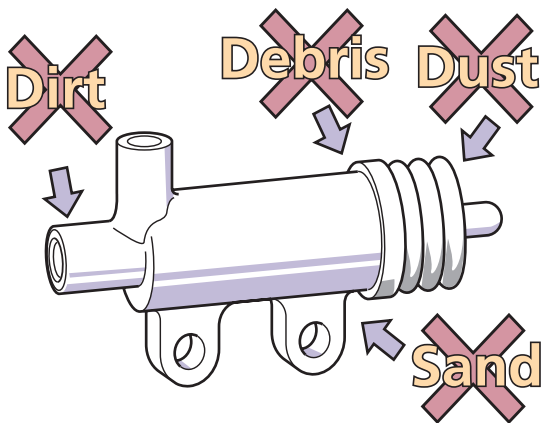

Internal damage may occur, resulting in fluid leakage and improper hydraulic pressure

## 2

Always use vehicle manufacturer specified fluid.

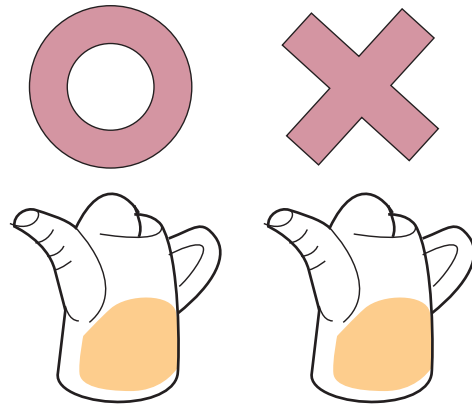

Sealing can be impaired if mineral additives are mixed with fluid which can cause clutch failure.

## 3

Tighten bolts, nuts, and screws as specified by the manufacturer's vehicle specific manual.

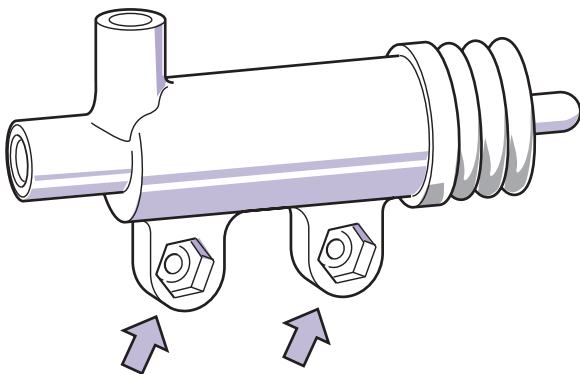

Damage of screws and threads may cause improper function.

## 4

Handle with care. Clutch release cylinders are precision manufactured. Do not drop or deform. Never use a damaged unit.

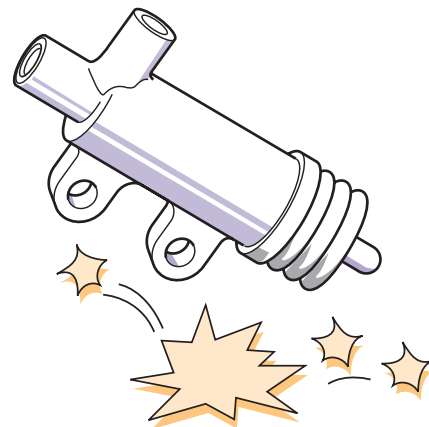

Optimal hydraulic pressure may not be achieved due to damaged internal parts, resulting in incorrect operation.